

Tenace - Round MA T - #1062



12W



1067lm



2700K



24°

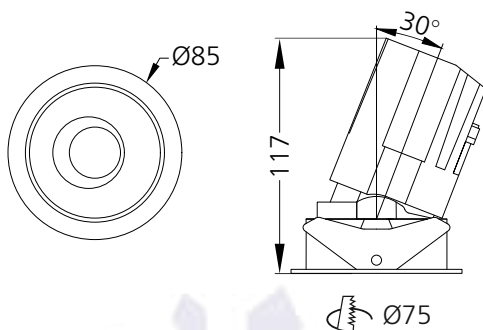

Photometric Data

Light source	LED - Array	Light output ratio	72%
Power (W)	12W	Color rendering index (Ra)	>95
Delivered lumens	1067lm	Color rendering index (R9)	>85
Source lumens	1464lm	Binning MacAdam	<2 SDCM
Colour temperature (K)	2700K	LED life	L90 B10 Tj75°C
Luminaire efficacy	88.97lm/W	UGR	<16
Beam angle	24°	Operating temperature	-20°C to +50°C
Cutoff angle	30°	Light distribution	Direct - Symmetric

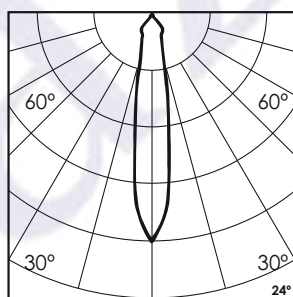
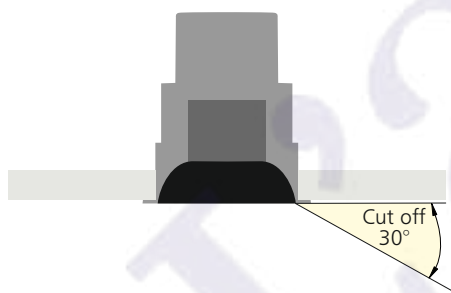

Technical Data

Mounting detail	Ceiling - Recessed 1-25mm	Product weight	367gms
Fixing detail	Dual tension spring	Safety class	III
Orientation	Adjustable	Insulation class	III
IP rating	IP65	LED current (mA)	300mA
Glow wire test	850°	Voltage	AC230V
Trim material	Diecast alm.	Forward voltage	DC36V
Heatsink material	Diecast alm.	Driver	CC - Remote

Photometric Graphs

Hue Bin vs Rf Graph

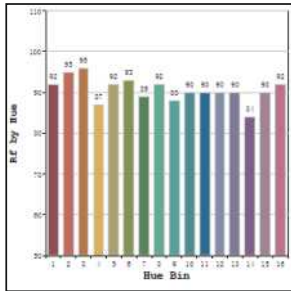

Color Vector Graph

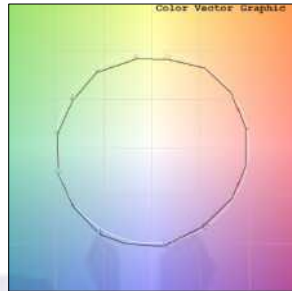

Spectrum vs Wavelength Graph

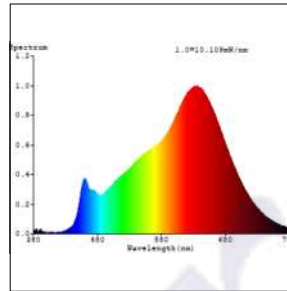

CIE Chromaticity Graph

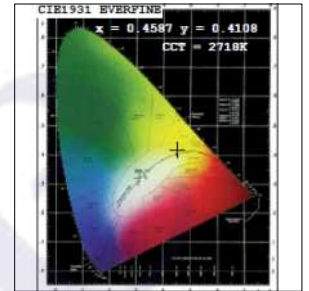

Finish Options

Trim Finish

- Matt White
- Matt Black
- Custom RAL Color

Reflector Finish

- Matt White
- Matt Black
- Specular
- Pearl Black
- Black Chrome
- Matt Silver
- Matt Gold

Filter Options



Honeycomb Filter



Diffusion Lens



Softening Lens

Above filters can be added to the fixture and need to be ordered as a separate accessory

Dimming Options



Constant Current Driver
12w 300mA 220-240V
Non Dimmable



Constant Current Driver
12w 300mA 220-240V
Triac Dimmable



Constant Current Driver
12w 300mA 220-240V
Analog 0-10V / 1-10V Dimmable



Constant Current Driver
12w 300mA 220-240V
Dali Dimmable



Constant Current Driver
12w 300mA 220-240V
Dali Tunable



Constant Current Driver
12w 300mA 220-240V
RF Tunable (operated with RF remote)

L'azure constantly strives to improve our products using the latest technological advancements in the industry.
Due to which the data mentioned in the data sheet is subject to change without prior notice.