

Joule Standard Magnetic - Track



**Surface Track
#2145**

- Shows an isometric render & 2D view of Joule Standard Magnetic Surface Track. Joule Standard Magnetic Surface Track can be selected considering the surface or pendant installation.
- Available accessories that is needed for installation of Joule Standard Magnetic Surface Track are mentioned below. Accessories needs to be ordered separately

Accessories



90° Corner



Outward Corner



Inward Corner



Blank Cover

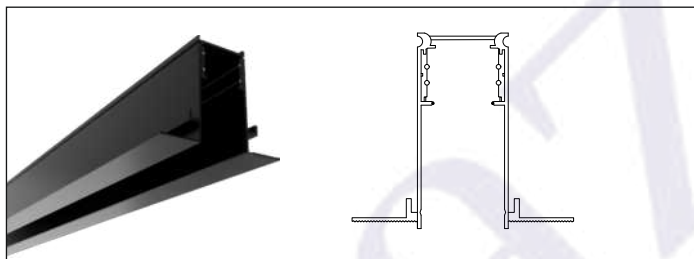

**Recessed Track
#2146**

- Shows an isometric render & 2D view of Joule Standard Magnetic Recessed Track. Joule Standard Magnetic Recessed Track can be selected considering the recessed installation.
- Available accessories that is needed for installation of Joule Standard Magnetic Recessed Track are mentioned below. Accessories needs to be ordered separately

Accessories



90° Corner



Outward Corner



Inward Corner



Blank Cover

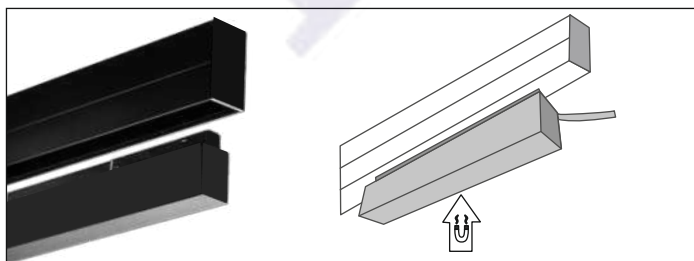

**Magnetic - Power Supply
#2169**

- Shows an isometric render & 2D view of Joule Standard Magnetic Power Supply. Joule Standard Magnetic Power Supply should be selected only for Non Dimmable option.
- Magnetic Power Supply is available in two different wattage 100w & 200w. This can be selected considering the wattage of number of luminaries installed.
- For Analog, Dali and Dali CCT tunable Dimming options remote power supply is needed. Both the inbuilt and remote power supply needs to be ordered separately depending on the dimming requirements.

Standard - Disc M - #2250



18W



1560lm



2700K



38°

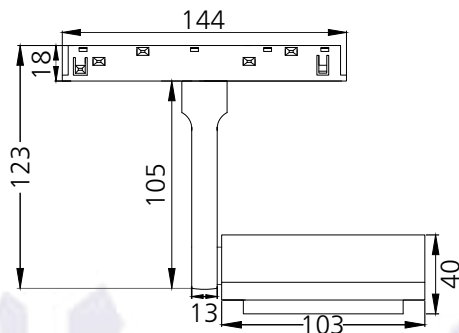

Photometric Data

Light source	LED - Array	Light output ratio	71%
Power (W)	18W	Color rendering index (Ra)	>95
Delivered lumens	1560lm	Color rendering index (R9)	>85
Source lumens	2196lm	Binning MacAdam	<2 SDCM
Colour temperature (K)	2700K	LED life	L90 B10 Tj75°C
Luminaire efficacy	86.7lm/W	UGR	<19
Beam angle	38°	Operating temperature	-20°C to +50°C
Cutoff angle	NA	Light distribution	Direct - Symmetric

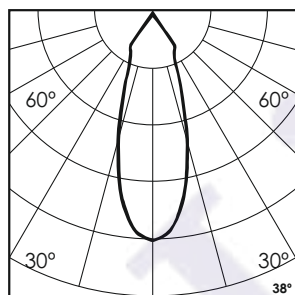

Technical Data

Mounting detail	Recessed	Product weight	468gms
Fixing detail	Dual tension spring	Safety class	III
Orientation	Adjustable	Insulation class	III
IP rating	IP20	Voltage	AC230V
Glow wire test	850°	Forward voltage	DC48V
Trim material	Aluminium	Driver	CV - Remote
Heatsink material	Aluminium Extrusion		

Photometric Graphs

Hue Bin vs Rf Graph

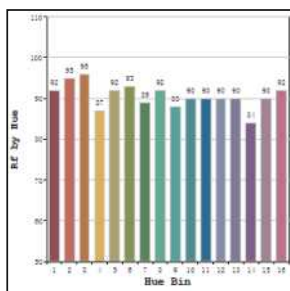

Color Vector Graph

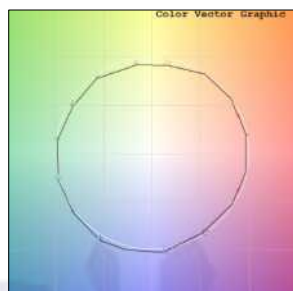

Spectrum vs Wavelength Graph

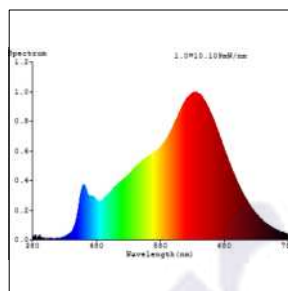

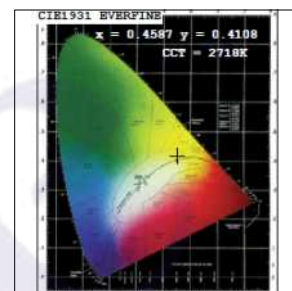

CIE Chromaticity Graph



Finish Options

Body Finish

-  Matt Black
-  Custom RAL Color

Filter Options



Honeycomb Filter

Above filters can be added to the fixture and need to be ordered as a separate accessory

Dimming Options



Non Dimmable Remote Driver



Analog 0-10V / 1-10V Dimmable Remote Driver



Dali Dimmable Remote Driver



Dali Tunable Remote Driver

L'azure constantly strives to improve our products using the latest technological advancements in the industry. Due to which the data mentioned in the data sheet is subject to change without prior notice.