

# Allura Mini S - #1043

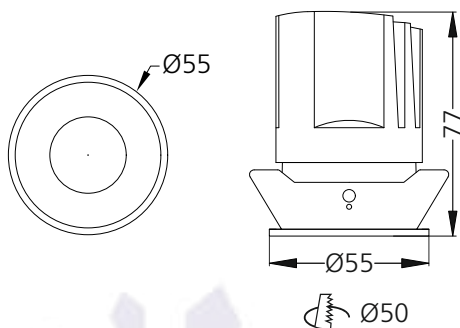

## Photometric Data

Light source	LED - Array	Light output ratio	64%
Power (W)	7W	Color rendering index (Ra)	>95
Delivered lumens	580lm	Color rendering index (R9)	>85
Source lumens	903lm	Binning MacAdam	<2 SDCM
Colour temperature (K)	4000K	LED life	L90 B10 Tj75°C
Luminaire efficacy	82.85lm/W	UGR	<19
Beam angle	15°	Operating temperature	-20°C to +50°C
Cutoff angle	18°	Light distribution	Direct - Symmetric

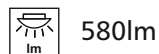
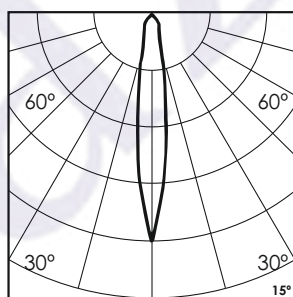
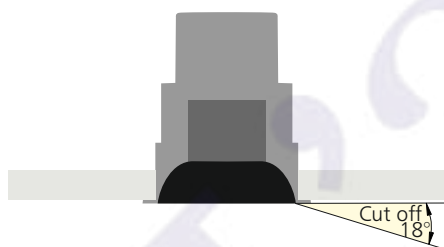

## Technical Data

Mounting detail	Ceiling - Recessed 1-25mm	Product weight	106gms
Fixing detail	Dual tension spring	Safety class	III
Orientation	Fixed	Insulation class	III
IP rating	IP44	LED current (mA)	190mA
Glow wire test	850°	Voltage	AC230V
Trim material	Diecast alm.	Forward voltage	DC36V
Heatsink material	Diecast alm.	Driver	CC - Remote

## Photometric Graphs

Hue Bin vs Rf Graph

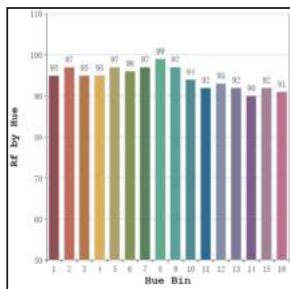

Color Vector Graph

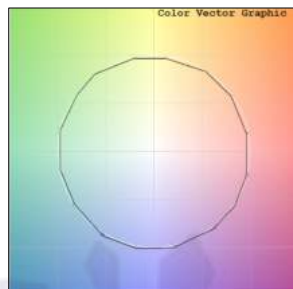

Spectrum vs Wavelength Graph

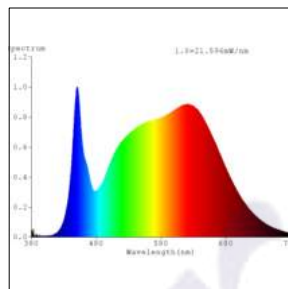

CIE Chromaticity Graph

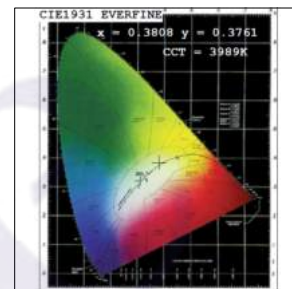

## Finish Options

### Trim Finish

- Matt White
- Matt Black
- Custom RAL Color

### Interior Finish

- Matt White

## Filter Options



Honeycomb Filter



Diffusion Lens



Softening Lens

Above filters can be added to the fixture and need to be ordered as a separate accessory

## Dimming Options



Constant Current Driver  
7w 190mA 220-240V  
Non Dimmable



Constant Current Driver  
7w 190mA 220-240V  
Triac Dimmable



Constant Current Driver  
7w 190mA 220-240V  
Analog 0-10V / 1-10V Dimmable



Constant Current Driver  
7w 190mA 220-240V  
Dali Dimmable



Constant Current Driver  
7w 190mA 220-240V  
Dali Tunable



Constant Current Driver  
7w 190mA 220-240V  
RF Tunable (operated with RF remote)

L'azure constantly strives to improve our products using the latest technological advancements in the industry.  
Due to which the data mentioned in the data sheet is subject to change without prior notice.