

Allura Mini L - #1045



15W



1234lm



3000K



24°

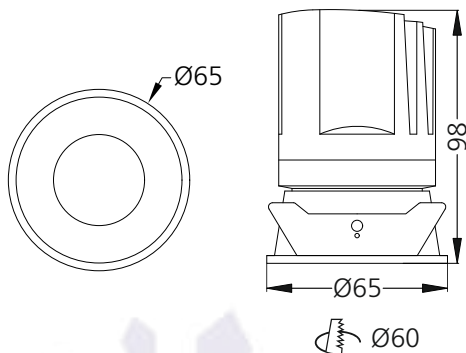

Photometric Data

Light source	LED - Array	Light output ratio	65%
Power (W)	15W	Color rendering index (Ra)	>95
Delivered lumens	1234lm	Color rendering index (R9)	>85
Source lumens	1875lm	Binning MacAdam	<2 SDCM
Colour temperature (K)	3000K	LED life	L90 B10 Tj75°C
Luminaire efficacy	82.31lm/W	UGR	<19
Beam angle	24°	Operating temperature	-20°C to +50°C
Cutoff angle	16°	Light distribution	Direct - Symmetric

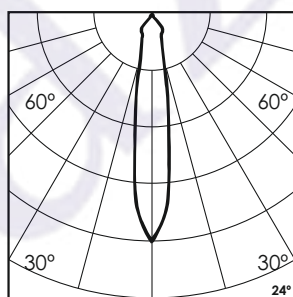
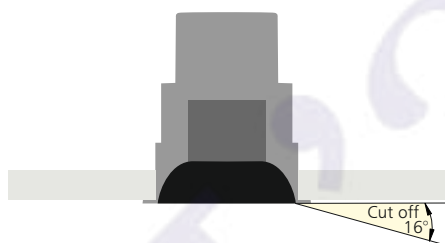

Technical Data

Mounting detail	Ceiling - Recessed 1-25mm	Product weight	203gms
Fixing detail	Dual tension spring	Safety class	III
Orientation	Fixed	Insulation class	III
IP rating	IP44	LED current (mA)	350mA
Glow wire test	850°	Voltage	AC230V
Trim material	Diecast alm.	Forward voltage	DC36V
Heatsink material	Diecast alm.	Driver	CC - Remote

Photometric Graphs

Hue Bin vs Rf Graph

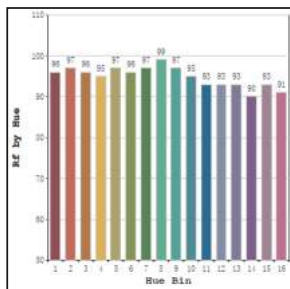

Color Vector Graph

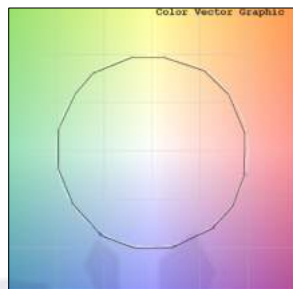

Spectrum vs Wavelength Graph

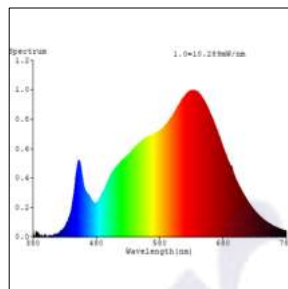

CIE Chromaticity Graph

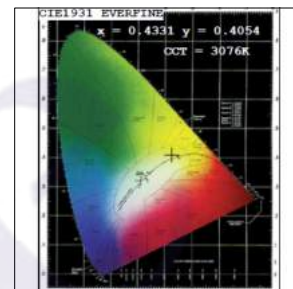

Finish Options

Trim Finish

- Matt White
- Matt Black
- Custom RAL Color

Interior Finish

- Matt White

Filter Options



Honeycomb Filter



Diffusion Lens



Softening Lens

Above filters can be added to the fixture and need to be ordered as a separate accessory

Dimming Options



Constant Current Driver
15w 350mA 220-240V
Non Dimmable



Constant Current Driver
15w 350mA 220-240V
Triac Dimmable



Constant Current Driver
15w 350mA 220-240V
Analog 0-10V / 1-10V Dimmable



Constant Current Driver
15w 350mA 220-240V
Dali Dimmable



Constant Current Driver
15w 350mA 220-240V
Dali Tunable



Constant Current Driver
15w 350mA 220-240V
RF Tunable (operated with RF remote)

L'azure constantly strives to improve our products using the latest technological advancements in the industry. Due to which the data mentioned in the data sheet is subject to change without prior notice.