

Pullout - Square M TL - #1233



12W



1085lm



4000K



10°

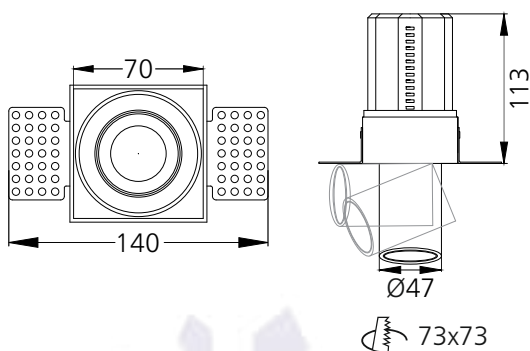

Photometric Data

Light source	LED - Array	Light output ratio	68%
Power (W)	12W	Color rendering index (Ra)	>95
Delivered lumens	1085lm	Color rendering index (R9)	>85
Source lumens	1584lm	Binning MacAdam	<2 SDCM
Colour temperature (K)	4000K	LED life	L90 B10 Tj75°C
Luminaire efficacy	90.41lm/W	UGR	<19
Beam angle	10°	Operating temperature	-20°C to +50°C
Cutoff angle	NA	Light distribution	Direct - Symmetric

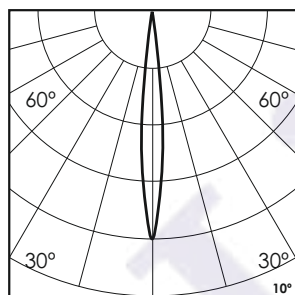

Technical Data

Mounting detail	Ceiling - Recessed 1-25mm	Product weight	286gms
Fixing detail	Mounting with Screw	Safety class	III
Orientation	Adjustable	Insulation class	III
IP rating	IP20	LED current (mA)	300mA
Glow wire test	850°	Voltage	AC230V
Trim material	NA	Forward voltage	DC36V
Heatsink material	Diecast alm.	Driver	CC - Remote

Photometric Graphs

Hue Bin vs Rf Graph



Color Vector Graph



Spectrum vs Wavelength Graph



CIE Chromaticity Graph



Finish Options

Trim Finish

- Matt White
- Matt Black
- Custom RAL Color

Interior Finish

- Matt White
- Matt Black
- Matt Silver
- Matt Gold

Filter Options



Honeycomb Filter



Softening Lens

Above filters can be added to the fixture and need to be ordered as a separate accessory

Dimming Options



Constant Current Driver
12w 300mA 220-240V
Non Dimmable



Constant Current Driver
12w 300mA 220-240V
Triac Dimmable



Constant Current Driver
12w 300mA 220-240V
Analog 0-10V / 1-10V Dimmable



Constant Current Driver
12w 300mA 220-240V
Dali Dimmable



Constant Current Driver
12w 300mA 220-240V
Dali Tunable



Constant Current Driver
12w 300mA 220-240V
RF Tunable (operated with RF remote)

L'azure constantly strives to improve our products using the latest technological advancements in the industry.
Due to which the data mentioned in the data sheet is subject to change without prior notice.