

Marcopia Round 3 - #3014



12W



909lm



Green



36°

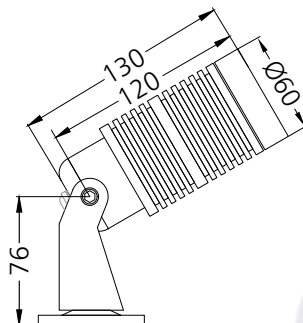
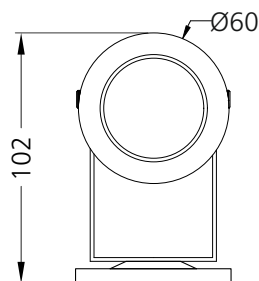

Photometric Data

Light source	LED - Array	Beam angle	36°
Power (W)	12W	Light output ratio	68%
Delivered lumens	909lm	LED life	L90 B10 Tj75°C
Source lumens	1320lm	UGR	<19
Colour temperature (K)	Green	Operating temperature	-20°C to +50°C
Luminaire efficacy	75.78lm/W	Light distribution	Direct - Symmetric

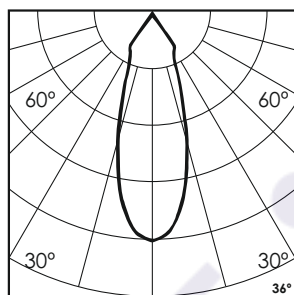

Technical Data

Mounting detail	Surface Uplighter	Heatsink material	Diecast alm.
Fixing detail	Cowl / Spike / Tree Strap / Mounting Plate	Product weight	528gms
Orientation	Adjustable	Safety class	III
IP rating	IP65	Insulation class	III
IK rating	IK05	Voltage	DC24V
Glow wire test	850°	Driver	Remote - DC24V

Finish Options

Body Finish

- Matt Grey
- Matt Black
- Custom RAL Color

Filter Options



Honeycomb Filter

Above filters can be added to the fixture and need to be ordered as a separate accessory

Accessories Options



Cowl



Spike



Tree Strap

Above accessories can be added to the fixture and need to be ordered as a separate accessory

Dimming Options



Remote DMX Decoder

The DMX Decoder requires a 24V CV Driver