

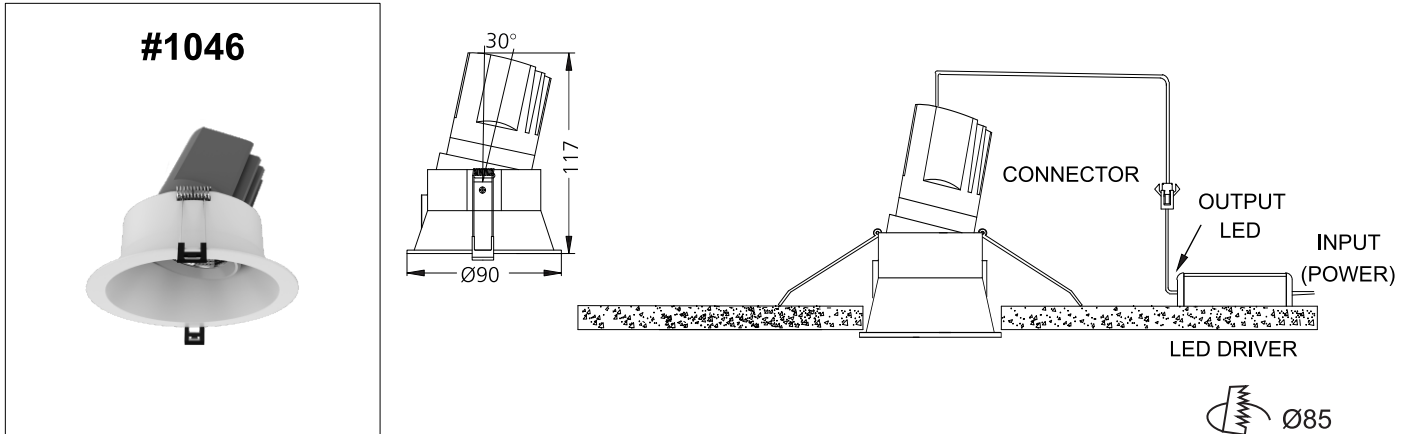

# ALLURA ROUND M



	<p><b>Class III</b> 220-240 V~50/60Hz</p>	<p><b>Power</b> 10 Watts</p>	<p><b>IP Rating</b> IP44</p>
-----------------------------------------------------------------------------------	-----------------------------------------------	----------------------------------	----------------------------------

**CAUTION** - Must Be Installed By A Licensed Electrician Only.

1. Please read the instructions for the installation of fixture provided below. Warranty will be void unless followed.
2. The installation and operation of this fixture must be in accordance with the national safety regulations. L'azure is not liable when damage is caused due to improper installation.
3. Please read the detailed product specification sheet available at [www.lazurelighting.com](http://www.lazurelighting.com) for any technical information regarding the fixture.
4. Over-voltage protection units should be installed in order to prevent electronic and electrical components from failing due to voltage spikes.

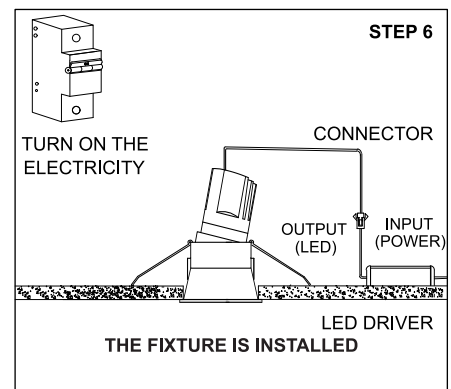
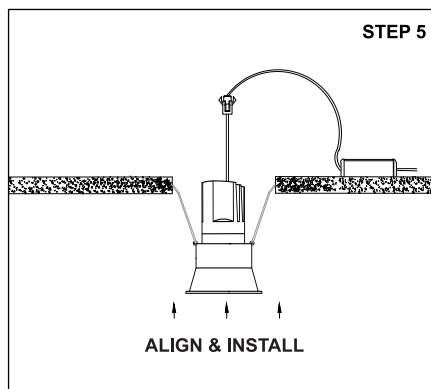
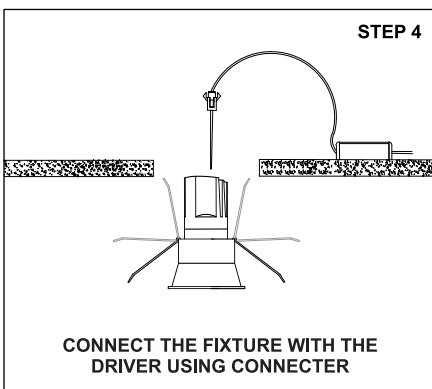
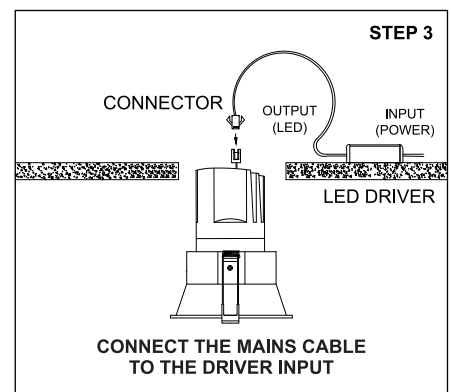
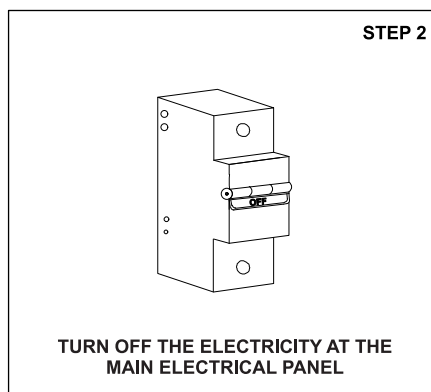
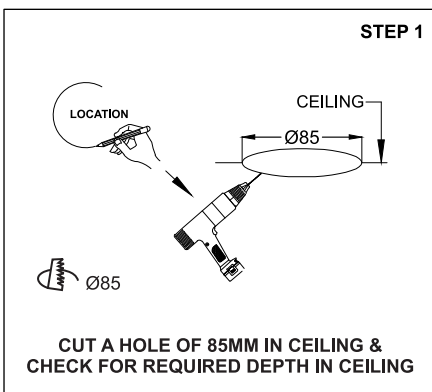

**Disclaimer :** 1. Due to continuous product improvement the installation method is subject to change.  
2. Images and procedures are for representation and reference purpose only.